

INSERTO BACK EFFECTO

This Technical Sheet is to be intended as an integral section of the Inserto Back Range Instruction Manual. Before use, it is essential for the professional user to explain all procedures for a correct commissioning and a proper standard maintenance.

1. Commissioning

The EFFECTO backrest of the Inserto Back Range is the evolution of the INSERTO SEAT concept. Its high versatility and adaptability offers to the end user the best performances of customisation as well as confort, lightness and protection.

The Inserto Back **Effecto** Trunk Positioning System is available in LATO version (pic 1) and in PLUS version (pic 2); it has been developed to provide support to all people with poor trunk control, severe deformities and lateral instability of the pelvis and trunk; It consists of an aluminium shell and a padding consisting of three layers of polyethylene foam with shock absorbing properties. The whole system is upholstered with not flammable cover, latex free with low risk of skin irritation, commonly used in medical devices. The peculiarity of this backrest is to be equipped with polyethylene inserts inside the cover. The inserts are multi-adjustable with hooks and loops and can be modified with a cutter to better adapt to the shape of the user's spine; the professional user has the responsibility to assemble in a proper way the backrest and position in a proper way the inserts with padding and cover. Pic 2 shows the inserts of one of the two EFFECTO range models. The two backrest models differs for the number of inserts identified with number 1. The three kind of inserts have specific tasks:

1 (thoracic containment inserts) it has the task to contain and support laterally the upper part of the chest, **2** (pushing lumbar contoured insert) It has the task to "wrap" and if necessary to push laterally the medium-low part of the thorax and/or the hips, **3** (lumbar support inserts) whose function is to support the lumbar curve.



Pic. 1: Effecto Lato



Pic. 2: Effecto Plus

2. Use

The **Inserto Effecto Lato** Trunk Positioning System is recommended preferably, but not exhaustively, for users with limited mobility:

- With poor control of the Trunk
- With pelvis/trunk instability
- With severe/very severe deformities.

The **Inserto Effecto Plus** Trunk Positioning System is recommended preferably, but not exhaustively, for users with limited mobility:

- With discrete control of the trunk
- With pelvis/trunk lateral instability
- With severe deformities.

3. Suggestions related to some operations

3.1 Check the diameter of the wheelchair tubes

The mounting system to the backrest canes (pic 3), allows the Backrest to be mounted on tubes with diameter from 19 mm to 25 mm or from 3/4" a 1" without using particular adaptation means; the only accuracy has to be taken to the screws shown in pic 3; the pre-assembled screws will be used on tubes with diameter between 23mm-29/32" and 25 mm.-1" The screws in the relevant wrap are for tubes with diameter between 22mm-7/8" and 19mm-3/4".



Proceed with the mounting once verified the compatibility of the backrest with the wheelchair tubes. It is recommended to mount the backrest without the end user seated on the wheelchair.

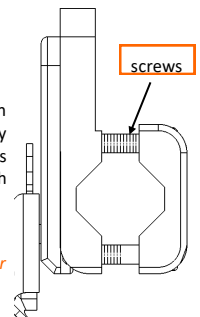

Pic. 3: mounting system

3.2 Mounting the backrest to the wheelchair

Proceed as follows:

- locate the two inferior attachments on the tubes by tightening the screw 1 and the screw 2; in order to have the two attachments at the same height A it is recommended to find a referring point which could be either the bottom of the back cane or the reclining plate
- thus locate the upper attachments always by tightening the screw 1 and the screw 2; in order to have the two attachments at the same height B take as reference the lower ones previously mounted. It is advisable to keep the attachments loosen before to proceed with the final adjustment of the backrest). Avoid to mount the attachments on tubes with small diameter because they can be damaged during tightening
- mount on the backrest already assembled brackets (pic 5) in the relevant slot of the wheelchair width by taking into consideration the table 1 (the brackets with the tab and the spring will be mounted on the top, the others on the bottom)
- the information given in table 1 is indicative for a tube diameter of 25 mm.

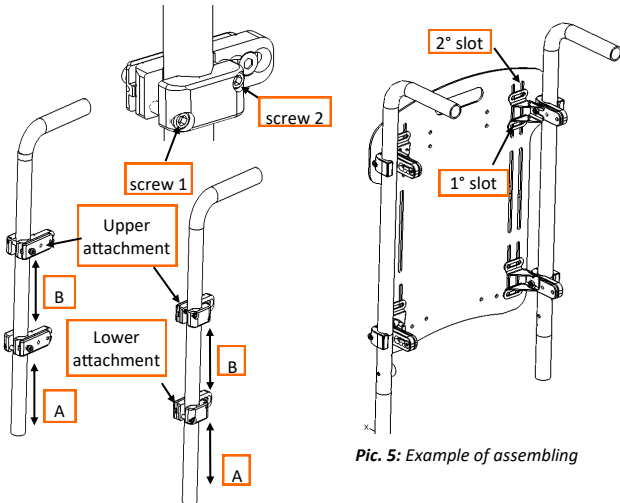

Pic. 5: Example of assembling

Backrest sizes	Frame width outside tubes-outside tubes (mm)
3033	1° slot 270-280-290; 2° slot 300-310-320-330
3338	1° slot 300-310-320; . 2° slot 330-340-350-360
3642	1° slot 330-340-350; 2° slot 360-370-380-390
3650	1° slot 330-340-350; 2° slot 360-370-380-390
3945	1° slot 360-370-380; 2° slot 390-400-410-420
3952	1° slot 360-370-380; 2° slot 390-400-410-420
4245	1° slot 390-400-410; 2° slot 420-430-440-450
4245	1° slot 390-400-410; 2° slot 420-430-440-450
4550	1° slot 420-430-440; 2° slot 450-460-470-480
4855	1° slot 450-460-470; 2° slot 480-490-500-510

Pic. 4: Example of attachments mounting

Table 1: Example of mounting on 25 mm diameter

Once the brackets have been mounted it is possible to proceed with the mounting of the backrest on the back canes:

- lean the backrest on the lower attachments being careful to place the bracket on the pivot nut as shown in pic 6 (in case of problems, please loose the brackets and proceed with the correct positioning)
- now lean the backrest on the upper attachments by verifying that the relevant brackets are at the same height of the back canes attachments, in a contrary case loose and proceed to the correct positioning.

The correct mounting is shown in pic 7 where the pivot nut of the upper attachment is located inside the locking tab.

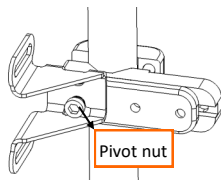

Pic. 6: Pivot nut

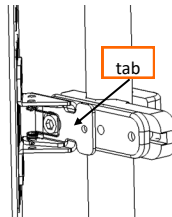

Pic. 7: Example of correct mounting



For a proper operation it is obligatory to leave unchanged the upper attachment kit that you will find inside the box as it is mounted (the space where there is the nylon washer will be used for the allocation of the tab).

3.3 Removal of the backrest from the wheelchair

For the removal of the backrest it is necessary to push the tabs inwards or to use the provided cord; then move the backrest slightly forward and rise it by using the handle located on the top.

3.4 Backrest Height adjustment

For the adjustment of the height it is possible to slide the attachments along the tubes as far as possible dictated by the length of the back canes or by the correct posture needed by the end user. In addition you can slide the brackets along the slots of the backrest. (pic 5)

3.5 Backrest Depth adjustment

Adjust the depth by loosening the countersunk head screw located on the upper and lower attachments pic 8 and move the guides forward; in case of any problem arising during the assembling it is necessary to adjust the brackets on the backrest. Once the desired depth is achieved, tighten the countersunk head screw and verify that the tabs are in the lock position and that the backrest is firmly in place.

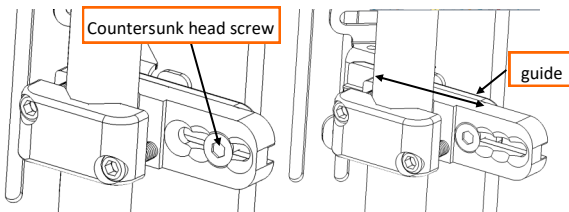

Pic. 8: Backrest depth adjustment

3.6 Backrest Reclining adjustment

Adjust the reclining of the backrest by loosening the countersunk head screw of the upper and lower attachments shown in pic 9 and move the guides forward; in case of any problem arising with the assembling it is necessary to adjust the brackets on the backrest. At the achievement of a proper inclination, tighten the countersunk head screws and/or all loosen screws and check that the tabs are in the lock position and the backrest is firmly in place.

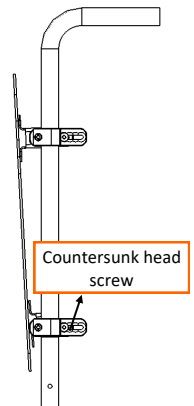

Pic. 9: Backrest reclining adjustment

3.7 Backrest Rotation adjustment

The rotation of the backrest is performed by loosening the countersunk head screw of the upper and lower attachments of the same side; then move the guides forward and rotate the two attachments around the tube at the required angle needed; on the other side it is also necessary to rotate the attachments until the right assembling is achieved. Once the right angle of rotation has been detected, tighten the countersunk head screws and/or all loosen screws and always verify that the two tabs are in the lock position and the backrest is firmly in place.

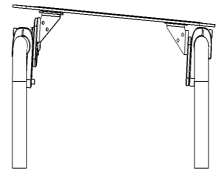

Pic. 10: Backrest rotation adjustment



After having performed any operations it is recommended to check that the backrest is firmly mounted on the back canes attachments and the tabs are in the lock position; any failure in the observance of the instructions in this manual will result in a malfunction of the device. Do not use the backrest to push or raise the wheelchair.



The attaching system of the back canes of the wheelchair as well as the guide-tabs system of the backrest have been tested in compliance with ISO 7176-19 Directive. Therefore, if the backrest is used in a motor vehicle, it must be mounted on a crash-tested wheelchair.

NOTE: It is strictly recommended the use of an headrest when the device is transported in a vehicle.

4. Accessories

The backrest can be equipped with accessories such as thoracic supports, headrest and harnesses.

4.1 Thoracic Support

For a correct use of these accessories please follow the instructions below:

- The thoracic support will be mounted between the cover and the shell with the supplied screws;
- The height adjustment can be performed by engaging the slots at the middle of the shell; the slots on the pad mounting bracket, with or without swing-away system, allow the adjustment of the thoracic width;
- The swing away mechanism is easy to use; the central body of the bracket is provided with a pushing button which, when operated, it will open up for enhancing user's transfers.

The thoracic support assembly is composed by a pad and a mechanism and/or a bracket (a fixed bracket). The thoracic support pad can be flat or contoured, on turn linear or armpit. The sizes (in centimetres) are reported in the following table 2.

The pad can be attached to the backrest with a fixed bracket or a detachable/swing-away mechanism. The type of the bracket, assembled to the pad, can be type A (L bracket) or type B (2,5 cm. Offset), depending upon the thoracic width of the user.

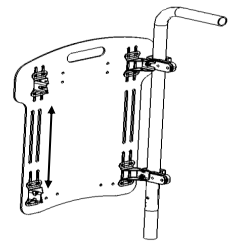

Pic 11 Thoracic support adjustment



It is recommended to use the thoracic support as a chest containment and not as a single point of support, as it may cause damage to the user.

	Linear	Armpit
Flat		
size 1*	6 x 8	N.D.
size 2*	8 x 10	8 x 10
size 3*	10 x 12	10 x 12
size 4*	12 x 15	12 x 15
size 5*	12 x 18	12 x 18

	Linear	Armpit
Contoured		
size 1*	6 x 12	N.D.
size 2*	8 x 14	8 x 14
size 3*	10 x 16	10 x 16
size 4*	12 x 19	12 x 19

Table 2 (* shown for labelling only)

4.2 Headrest and Harnesses

- the holes located to the sides of the handle and at the bottom of the backrest shell can be engaged for mounting the harnesses (for adjustments see the relevant Versa Fixatis instruction manual)
- the holes located under the handle can be engaged for mounting an headrest; the two central holes can be used for a central position of the headrest. Upon request, it is possible to mount on the backrest an universal plate (for adjustments see the relevant Versa Capitis instruction manual).



After each operation has been performed it is strictly recommended to verify that the backrest is firmly mounted on the back canes attachments, the tabs are in the lock position and all accessories work perfectly. The inobservance of the instructions may affect the performances and functionality of the device.

5. Maintenance and cleaning

In order to avoid the development of infections, it is recommended to perform a careful cleaning every 2 weeks and/or, if needed, check the trunk positioning system in all its parts by avoiding malfunctions.

In order to guarantee a good functioning and long lasting performances in safe conditions it is necessary to check regularly and make periodically maintenance (tightening screws) to ensure that no sores due to excessive pressure have been developed.

This operation must be performed by the end user.

The regular maintenance consists of two parts: cleaning and mechanical parts checking

- Cleaning -

The metal parts can be cleaned with a damp cloth with cold water without addition of detergent, taking care to go over everything with a dry cloth. Regarding the removable cover of the backrest and thoracic supports, they can be washed in

tepid water at max 30° with the addition of a light, not aggressive detergent, bleach free. Then dry away from heat sources. The padding, even if it is not in direct contact with the user's skin, in order to avoid infections can be simply cleaned with a damp cloth or a brush with natural bristles (do not clean with water).

- Mechanical parts checking -

The operations to perform are the following:

- monthly check the tightening of the screw
- checking the adjustments: it is recommended to respect the checking plan scheduled with the professional user to check all adjustments and settings
- periodically check the thoracic support mechanism and the attaching hardware on the back canes of the wheelchair.

For further information, please contact our technical-Sales Department at the following number:



Backrest technical features					User Measures	
SIZE (cm)	Shell height (cm)	Mounting on wheelchair (outside tubes-outside tubes)(cm)	Reclination (°)	Rotation (°)	Trunk width achieved with thoracic supports (cm)*	
30x33	33	from 27 to 33	-7° to +7°	-5° to +5°	13-23	w/thor. sup. bracket Type "B"
					18-28	w/thor. sup. bracket Type "A"
33x38	38	from 30 to 36			16-26	w/thor. sup. bracket Type "B"
					21-31	w/thor. sup. bracket Type "A"
36x42	42	from 33 to 39			19-29	w/thor. sup. bracket Type "B"
					24-34	w/thor. sup. bracket Type "A"
36x50	42	from 33 to 39			19-29	w/thor. sup. bracket Type "B"
					24-34	w/thor. sup. bracket Type "A"
39x45	45	from 36 to 42			22-32	w/thor. sup. bracket Type "B"
					27-37	w/thor. sup. bracket Type "A"
39x52	45	from 36 to 42			22-32	w/thor. sup. bracket Type "B"
					27-37	w/thor. sup. bracket Type "A"
42x45	45	from 39 to 45			25-35	w/thor. sup. bracket Type "B"
					30-40	w/thor. sup. bracket Type "A"
42x50	50	from 39 to 45			25-35	w/thor. sup. bracket Type "B"
					30-40	w/thor. sup. bracket Type "A"
45x50	50	from 42 to 48			28-38	w/thor. sup. bracket Type "B"
					33-43	w/thor. sup. bracket Type "A"
48x55	55	from 45 to 51			31-41	w/thor. sup. bracket Type "B"
					36-46	w/thor. sup. bracket Type "A"
Diameter of wheelchair tubes for attachment mounting: 19 mm to 25 mm and 3/4" to 1"						

MANUFACTURED BY:

 **Promedicare**

Feel the ideal posture

Pro Medicare S.r.l.

Via Montagna Z.I. - Lotto 41 72023 Mesagne (BR) - ITALY

Tel. +(39) 0831 777840

Email: sales@promedicare.it - www.promedicare.eu