

Order Quotation

Invoicing Details	Shipping Details
Company name: _____ Delivery date required: ___ / ___ / ___ Delivery address: _____ P. Code.: _____ Town: _____ Tel.: _____ Fax: _____ # Order: _____ Date of the Order: ___ / ___ / ___	Ship to: _____ _____ <div style="text-align: center; border: 1px solid black; padding: 5px; margin-top: 10px;">CUSTOMER STAMP AND SIGNATURE</div>

Pro Medicare srl grants **24 months** warranty on production defects from the date of the first put into service and **12 months** on covers and components subjected to wearing. Warranty is void if the product is used in any other way than stated in the Instruction Manual.

Note: Any request for variation in dimensions, materials and type compared to the standard does not have **CE** marking, therefore the professional user becomes the manufacturer and has the obligation to draw up the technical documentation of the device.

Images are purely illustrative and may not fully reflect reality.

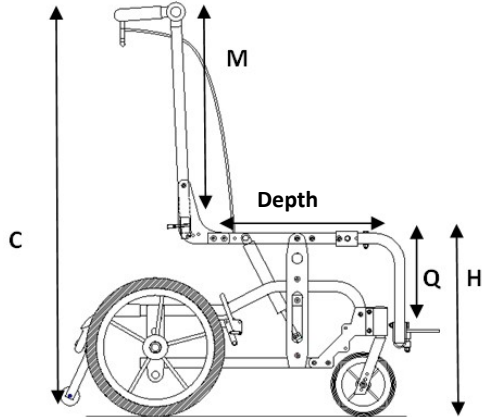
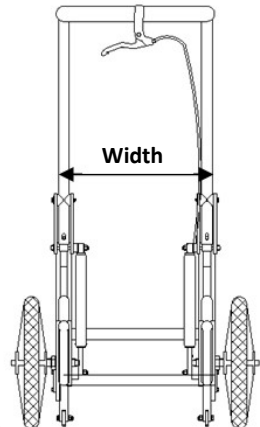
Standard Configuration																									
<ul style="list-style-type: none"> - Adacta titanium satin anodised frame with colored plates - Adjustable single handlebar with folding backrest tubes - Reclining mechanism by predetermined plate w/pin 3°, 10°, 18° - Continuous Tilt in space by pedal: from 2° up to 35° (from 6° up to 39°)¹ ¹ tilt in space can be up-graded of 4° with an increment of the starting inclination of the frame by operating on the positioning holes of the casters forks - Fixed anti-tip system - Wheels Kit with brake - Adjustment of the seat depth - Height adjustment: high (49 cm from the floor)/ low (43 cm from the floor)* *(with 300mm and 500mm wheels only) - Knee Angle - Foot Plates - Simple Calf Strap <p> <input checked="" type="checkbox"/> = Standard <input type="checkbox"/> = Optional without up-charge <input type="checkbox"/> = Optional with up-charge </p> <p>Note: If a selection is not made, the product will be delivered in its standard configuration. (See bold items)</p>																									
<p>◆ = Standard <input type="checkbox"/> = Optional without up-charge <input type="checkbox"/> = Optional with up-charge</p> <p>Note: If a selection is not made, the product will be delivered in its standard configuration. (See bold items)</p>																									
<p><u>Rigid Frame Structure</u></p>																									
<p><u>Frame Color</u></p>	<p>Titanium satin anodised frame with colored plates:</p> <p><input type="checkbox"/> Blue <input type="checkbox"/> Pink <input type="checkbox"/> Bordeaux</p>																								
<p><u>Frame size</u></p> <p><small>(Width measurements are from tube to tube externally, while depth measurements are from back post to footboard engagement)</small></p>																									
<table border="1" style="width: 100%; border-collapse: collapse;"> <thead> <tr> <th style="width: 15%;">Size</th> <th style="width: 20%;">Seat Width (cm)</th> <th style="width: 65%;">Depth and adjustments (cm)</th> </tr> </thead> <tbody> <tr> <td style="text-align: center;">○ 1</td> <td style="text-align: center;">25</td> <td style="text-align: center;">○ 32 ◆ 34.5 ○ 37</td> </tr> <tr> <td style="text-align: center;">○ 2</td> <td style="text-align: center;">25</td> <td style="text-align: center;">○ 36 ◆ 38.5 ○ 41</td> </tr> <tr> <td style="text-align: center;">○ 3</td> <td style="text-align: center;">30</td> <td style="text-align: center;">○ 32 ◆ 34.5 ○ 37</td> </tr> <tr> <td style="text-align: center;">○ 4</td> <td style="text-align: center;">30</td> <td style="text-align: center;">○ 36 ◆ 38.5 ○ 41</td> </tr> <tr> <td style="text-align: center;">○ 5</td> <td style="text-align: center;">35</td> <td style="text-align: center;">○ 36 ◆ 38.5 ○ 41</td> </tr> <tr> <td style="text-align: center;">○ 6</td> <td style="text-align: center;">35</td> <td style="text-align: center;">○ 40 ◆ 42.5 ○ 45</td> </tr> <tr> <td style="text-align: center;">○ 7</td> <td style="text-align: center;">38</td> <td style="text-align: center;">○ 40 ◆ 42.5 ○ 45</td> </tr> </tbody> </table>	Size	Seat Width (cm)	Depth and adjustments (cm)	○ 1	25	○ 32 ◆ 34.5 ○ 37	○ 2	25	○ 36 ◆ 38.5 ○ 41	○ 3	30	○ 32 ◆ 34.5 ○ 37	○ 4	30	○ 36 ◆ 38.5 ○ 41	○ 5	35	○ 36 ◆ 38.5 ○ 41	○ 6	35	○ 40 ◆ 42.5 ○ 45	○ 7	38	○ 40 ◆ 42.5 ○ 45	<p>H: seat rails to floor height (see page 4) Q: length from seat rails to footplate (see page 4) C: push handles height to floor = 110 cm M: push handles height from seat rails (see page 2)</p>
Size	Seat Width (cm)	Depth and adjustments (cm)																							
○ 1	25	○ 32 ◆ 34.5 ○ 37																							
○ 2	25	○ 36 ◆ 38.5 ○ 41																							
○ 3	30	○ 32 ◆ 34.5 ○ 37																							
○ 4	30	○ 36 ◆ 38.5 ○ 41																							
○ 5	35	○ 36 ◆ 38.5 ○ 41																							
○ 6	35	○ 40 ◆ 42.5 ○ 45																							
○ 7	38	○ 40 ◆ 42.5 ○ 45																							

FRAME OPTIONS

Castors

150mm (6") poly grey black 175mm (7") poly grey black

Posterior Wheels

300mm (12") poly grey with parking brake lever
 300mm (12") poly black with parking brake lever
 300mm (12") pneumatic grey with parking brake lever

300mm (12") poly black with drum brake
 300mm (12") poly grey with drum brake
 300mm (12") pneumatic grey with drum brake

300mm (12") poly black with drum brake and parking brake lever
 300mm (12") poly grey with drum brake and parking brake lever
 300mm (12") pneumatic grey with drum brake and parking brake lever

400mm (16") poly black with parking brake lever (only 45 cm height)

400mm (16") poly black with drum brake (only 45 cm height)

400mm (16") poly black with drum brake and parking brake lever (only 45 cm height)

500mm (20") poly grey without handrims with parking brake lever

500mm (20") pneumatic grey without handrims with parking brake lever

handrims for 500mm (20") wheels

500mm (20") pneumatic grey with handrims with drum brake

500mm (20") pneumatic grey with handrims with drum brake and parking brake lever

Knee Angle

not required*

RH LH

*knee angle and footrest

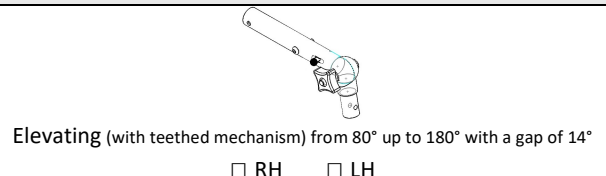

Footrest

footplates footboard slotted (on footplates only for intra-extra rotation of 15°)

padding and cover in leather flex

divided

one piece

Back Posts

Folding down back posts with adjustable angle handlebar

Kit for fixed push handles

Note: height M push handles equal to 63 cm

Kit for telescopic and angle adjustable single handlebar

Kit for telescopic push handles with lever block (max adjustment 10 cm)

Kit for angle adjustable separated handlebar

Quick-release pins for easier back reclining (not valid for crash test)

Tilt in space

with pedal with lever

Anti-tip system

fixed

detachable

FRAME ACCESSORIES

Seat Base **Note:** The wooden seat bases present posterior notches of 6 cm for easy movement on the seat rails

wooden grey (with male and female hook and loop fastening straps)

in refined wood with mounting kit (assembly of the various threaded inserts and clamps must be performed by the customer)

fixed grey wooden seat base with slots

Abductor wedge only with rigid seat base

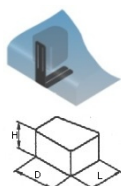

Size (cm)	<input type="checkbox"/> S	<input type="checkbox"/> M
H	7.5	9
D	9	10
L	7.5	9

removable with lever



removable with mounting block



Note: if not indicate the abductor wedge will be removable with lever

Please indicate the position of holes under the seat
(if not indicated the abductor wedge will be fixed in the standard position)

standard

not centred

on the RH

on the LH

Vehicle Transportation Kit (according to the ISO 7176-19 standard)

Do not use the wheelchair as a seat in a vehicle if the weight of the user is lower than 22 kg

- only frame height 43 cm and with 300mm (12") and 500mm (20") posterior wheels *(it is strongly recommended the use of a headrest)*

Wooden Supporting Base for Breathing Equipment available with tilt in space with lever only

Note: Bulky equipments may lead to a reduction of the tilt in space /reclining values

- covered in black leather flex

Please report sizes: Width _____; Length _____; Height _____; NOTE _____

Note: Pro Medicare Srl reserves the right to check wheelchair compatibility

Pedal for barriers

Side RH LH

Leg Support

Separate Leg Cradle RH LH *adjustable in height and depth*

	cm	1	2	3	4	5	6	7
	H	6	6	10	10	12,5	12,5	15
	L	6	6	9,5	9,5	12,5	12,5	12,5

Calf Panel *adjustable in height and depth*

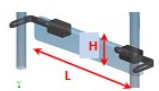
	cm	1	2	3	4	5	6	7
	H	8	8	10	10	12	12	15
	L	17	17	23	23	26,5	26,5	25

Padded calf strap

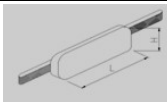
	cm	1	2	3	4	5	6	7
	H	11	11	11	11	11	11	11
	L	20	20	26	26	31	31	34

Cover for Knee Angle joint RH LH **Cover for legrest tube** RH LH



Armrest

- Height adjustable flip back tubular armrests/inclination max 5°**
(L = 25 cm) 

- Multi-adjustable and detachable hips and arms positioning kit**
 - **pelvis:** width, depth, height, adduction/abduction adjustable
 - **arm support:** width, depth, height, inclination, intra/extra-rotation adjustable

For independent adjustments referring to the width the gap is 3 cm

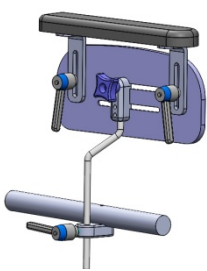
The armrests and the hip guides are assembled on the frames as the following indications without possibilities to be modified

 - small** (from frame size 1 up to 4)
(armrests dimensions: 8 cm x 22 cm)
(hips guide dimensions: 25 cm x 10 cm with slot of 5 cm)
 - large** (from frame size 5 up to 7)
(armrests dimensions: 10 cm x 30 cm)
(hips guide dimensions: 30 cm x 12 cm with slot of 7.5 cm)

Tray (recommendation for choice: size 1 for Giò size 1 and 2, size 2 for Giò size 3 and 4, size 3 for Giò size 5, 6 and 7)

<p>grey wooden with body contouring recess and edges</p> <p><input type="checkbox"/> standard option</p> <p><input type="checkbox"/> larger option for daily activities</p>	with Hardware	<input type="checkbox"/> w/lateral flip	<input type="checkbox"/> detachable	Type of hardware	
	<p><input type="checkbox"/> transparent with body contouring recess and edges <i>(only standard option)</i></p>	with Hardware	<input type="checkbox"/> w/lateral flip	<input type="checkbox"/> detachable	 lateral flip

Padding upper lower

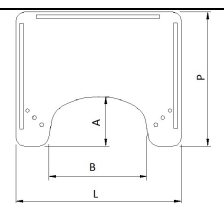
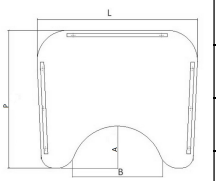
standard option dimensions						larger option for daily activities dimensions					
	Size (cm)	P	L	B	A		Size (cm)	P	L	B	A
	1	40	48	28	13		1	45	52.5	28	13.5
	2	45	58	35	15		2	50	62.5	36	15.5
	3	50	66	40	19		3	55	71	42	19.5

VERSA-FIXATIS FASTENERS

Pelvic Belt with 2 fixing points and 2 adjustments with plastic side squeeze buckle

	cm	<input type="checkbox"/> XS	<input type="checkbox"/> S
	H (pad height)	4.5	5.5
	L (pad length)	12	17

Pelvic Belt with 2 fixing points and 2 adjustments with metal push button buckle

	cm	<input type="checkbox"/> S	<input type="checkbox"/> M
	H (pad height)	6	7
	L (pad length)	17	22

Pelvic Belt with 4 fixing points and 2 adjustments with metal push button buckle

	cm	<input type="checkbox"/> S	<input type="checkbox"/> M
	H (pad height)	6	7
	L (pad length)	17	22

OTHER ACCESSORIES

			
<p>Canopy adaptor included</p> <p><input type="checkbox"/> Blue <input type="checkbox"/> Pink <input type="checkbox"/> Bordeaux</p>	<p>Foot Muff</p> <p><input type="checkbox"/> Blue <input type="checkbox"/> Pink <input type="checkbox"/> Bordeaux</p>	<p><input type="checkbox"/> Rain cover</p>	<p><input type="checkbox"/> Basket</p>

FRAME DIMENSION AND FEATURES

Size	1	2	3	4	5	6	7
Load (kg)/Frame Weight* (kg)	30/12.6	30/12.8	50/13.4	50/13.6	50/14.1	50/14.5	50/15.1

* Weight of the frame, including wheels, knee angle and footplates as standard configuration

Weight and overall dimensions (cm) of the frame with backrest tubes folded down, footrest and posterior wheels detached

Size	1	2	3	4	5	6	7
Length	64	66	64	66	66	68	68
Width	38	38	42	42	48	48	51
Height	64	64	65	65	66	66	67
Weight (kg)	9.4	9.6	10.1	10.3	10.7	11.1	11.5

Note: The length dimensions, referred to the average values, are subjected to the variations due to the displacement of the wheel plates. The values reported are intended for the standard configuration

Width (cm)

Size	1	2	3	4	5	6	7
300mm wheel	standard	43	43	48	48	53	56
	w/drum brake	44	44	49	49	54	57
400/500mm wheel	standard	45	45	50	50	55	58
	w/drum brake	48	48	53	53	58	61
Pivot Width (cm)	66	66	69	69	72	72	75
Q*(min-max) Height Seat rail to footplate (cm)*	13-20	13-20	13-23	13-23	13-23	13-26	13-26
H Seat rail to floor (cm)**	43 and 49 with 300/500mm posterior wheels and 150/175mm castors 45 with 400 mm posterior wheel and 150/175 castors						
Max Slope	7°						

Note: * The value Q, referred to 90° footrest hanger, can be increased of about 5-7 cm by using the 75° hanger

** The value H has been detected outside the seat tube at the plate of the tilt mechanism; the frame will be delivered with H=43 cm

Max length (cm) with 75° hanger							
Size	1	2	3	4	5	6	7
300mm wheel	86	89	86	89	89	92	92
400mm wheel	87	90	87	90	90	94	94
500mm wheel	91	94	91	94	94	97	97

Note: The length dimensions, referred to the average values, are subjected to variations due to the displacement of the wheel plates. The values reported are intended for the standard configuration

NOTE:

Large empty table area for additional notes.



PRO MEDICARE S.r.l.
 Via Montagna Z.I. Lotto 41-72023 Mesagne (Br)-ITALY
 Tel: +39-0831-777840 Fax:+39-0831-730739
 Website: www.promedicare.eu e-mail: sales@promedicare.it